



XML8150

INSTALLATION/OWNER'S MANUAL

AM/FM Receiver with Docking Station for iPod® and iPhone®



MP3

AAC

WMA

AUX
Front Panel Input

Made for
 iPod  iPhone

USB





Preparation

Please read entire manual before installation.

Before You Start

- Disconnect negative battery terminal. Consult a qualified technician for instructions.
- Avoid installing the unit where it would be subject to high temperatures, such as from direct sunlight, or where it would be subject to dust, dirt or excessive vibration.

Getting Started

- Remove trim ring from unit.
- Insert the supplied keys into the slots as shown, and slide the unit out of the mounting sleeve.
- Install mounting sleeve into opening, bending tabs to secure.
- Connect wiring harness and antenna. Consult a qualified technician if you are unsure.
- Certain vehicles may require an installation kit and/or wiring harness adapter (sold separately).
- Test for correct operation and slide unit into mounting sleeve to secure.
- Snap trim ring into place.

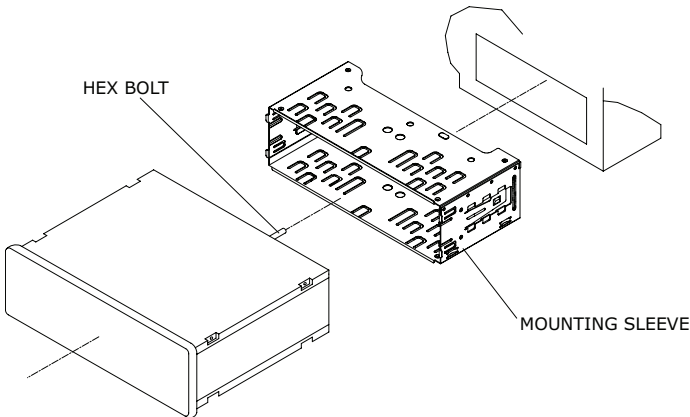
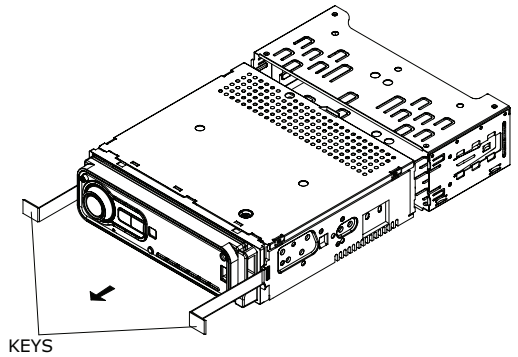

TYPICAL FRONT-LOAD DIN MOUNTING METHOD



Wiring Diagram

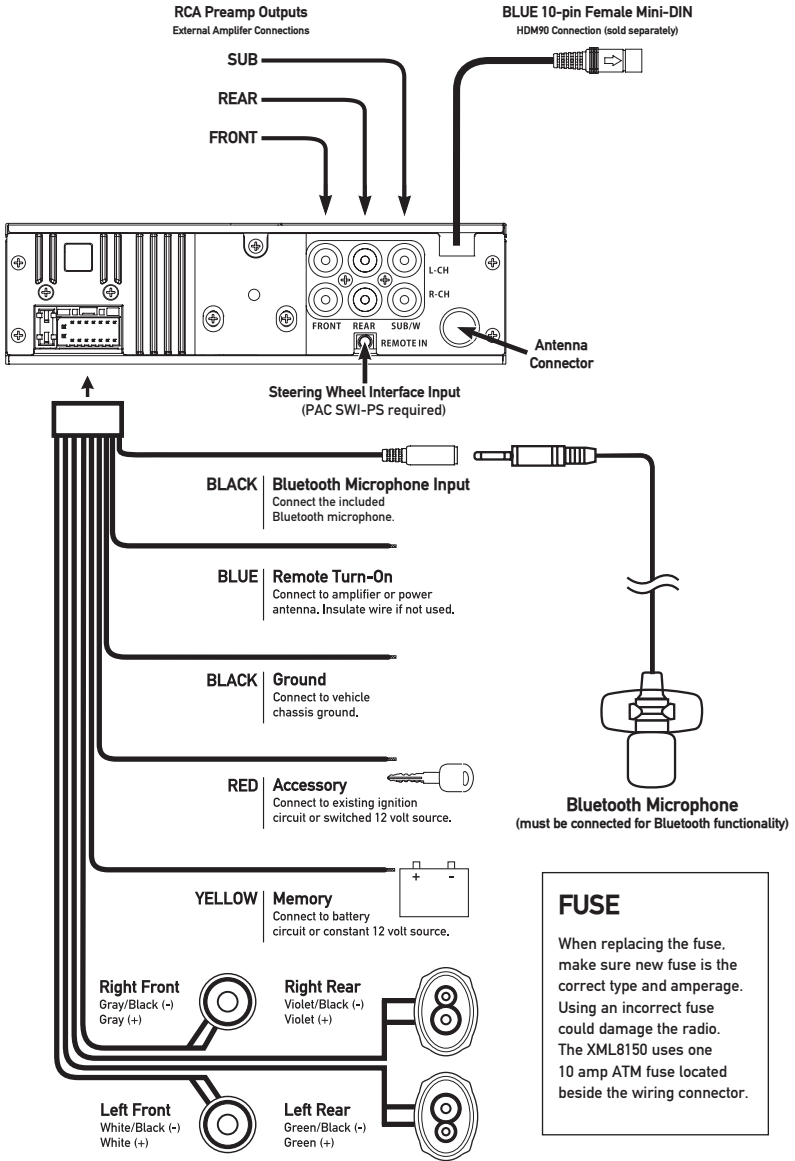

Control Locations - Receiver

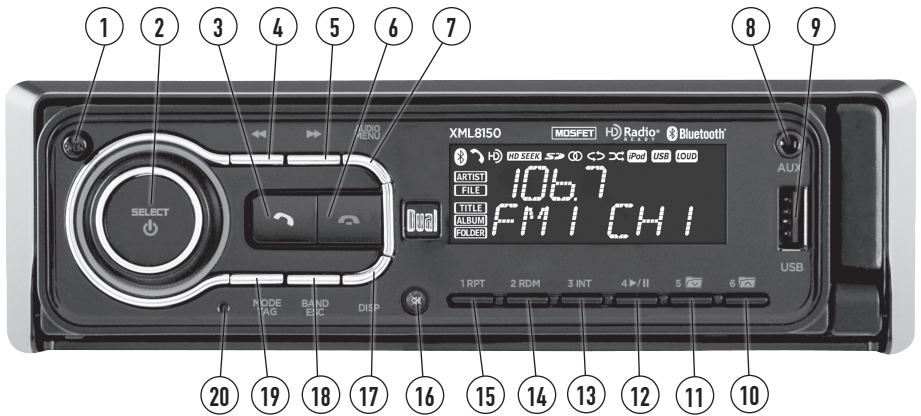

- | | |
|------------------------|---------------------------|
| ① Front Panel Release | ⑪ Preset 5 / Folder Down |
| ② Select / Power (⏻) | ⑫ Preset 4 / Play / Pause |
| ③ Talk | ⑬ Preset 3 / Intro |
| ④ Tune / Track Down | ⑭ Preset 2 / Random |
| ⑤ Tune / Track Up | ⑮ Preset 1 / Repeat |
| ⑥ End Call | ⑯ Mute |
| ⑦ Audio / Menu | ⑰ Display |
| ⑧ Auxiliary Input | ⑱ Band / Escape |
| ⑨ USB Port | ⑲ Mode |
| ⑩ Preset 6 / Folder Up | ⑳ Reset |



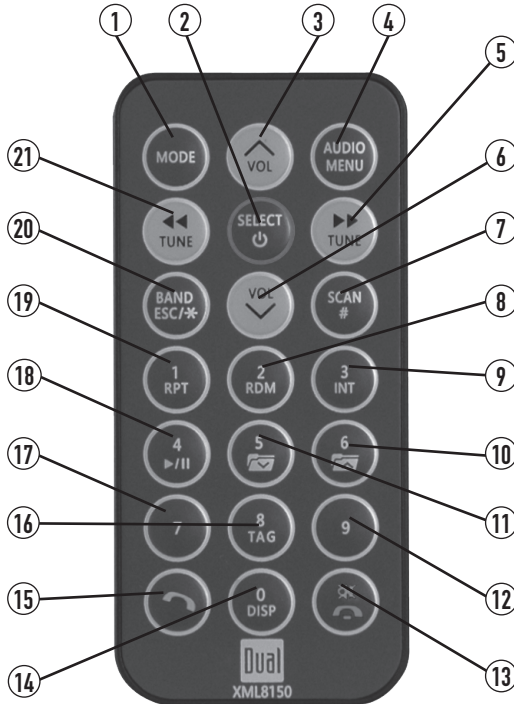



Control Locations - Remote



- | | |
|--------------------------|---------------------------|
| ① Mode | ⑫ Key 9 |
| ② Select / Power (⏻) | ⑬ Mute / End Call |
| ③ Volume Up | ⑭ Key 0 / Display |
| ④ Audio / Menu | ⑮ Talk |
| ⑤ Tune / Track Up | ⑯ Key 7 |
| ⑥ Volume Down | ⑰ Preset 4 / Play / Pause |
| ⑦ Scan / Key # | ⑱ Preset 1 / Repeat |
| ⑧ Preset 2 / Random | ⑲ Preset 1 / Repeat |
| ⑨ Preset 3 / Intro | ⑳ Band / ESC / Key * |
| ⑩ Preset 6 / Folder Up | ㉑ Tune / Track Down |
| ⑪ Preset 5 / Folder Down | |



General Operation

Power On/Off	Press  or any other button to turn unit on. Press and hold  to turn unit off.
Mode	Press MODE to select between AM/FM, auxiliary input, operation of iPod, USB, SD and Bluetooth modes. Modes of operation are indicated in the display. Note: Operation of iPod mode will not appear unless an iPod device has been connected. USB and SD modes will not appear unless a USB device has been connected or SD card has been inserted. Note: iPod and iPhone devices may be connected to the fold-out dock or directly to the USB port on the XML8150.
Steering Wheel Interface Input	The steering wheel interface input located on the back of the head unit allows connection to the PAC (Pacific Accessory Corporation) SWI-PS interface module (sold separately). Visit www.pac-audio.com for details. To configure steering wheel controls, follow the instructions provided with the PAC SWI-PS interface module. After installing the interface module, insert the module's 3.5mm jack into the port on the back of the head unit.
Auxiliary Input	Insert 3.5 mm plug to connect your portable audio device.
Volume	Adjust volume using volume knob (00-46).
Mute	Press  to silence the audio. "MUTE" will flash in the display. Press  again to cancel.
Reset	Press the RESET button, located on the front panel, to reset the unit back to the factory settings if abnormal operation occurs.
Display	Press DISP to toggle between items such as clock, radio frequency, or ID3 tag song information.
Set the Clock	With the unit on, press and hold DISP until the clock begins to flash, then release. Press TUNE  to adjust the hours and TUNE  to adjust the minutes. Press DISP momentarily to save the selected time.
12/24-Hour Clock	The clock will display 12-hour AM/PM time in USA frequency spacing mode (PM 10:00). In European frequency spacing mode, the clock will display 24-hour time (22:00). Note: 24-hour time and European frequency spacing are not available if the HDM90 HD Radio™ tuner are connected.
Setup Menu	Press and hold AUDIO/MENU for more than 3 seconds to access the setup menu, then press AUDIO/MENU to cycle through menu options. When desired option appears in the display, rotate the volume knob left/right to adjust or activate desired function. Press ESC to exit any menu or submenu.

General Operation

Setup Menu

Menu Function	Options	Action
Auto Station Store	AUTO PGM STATIONS	Press SELECT to begin automatically programming strong radio stations to the 6 preset buttons in the current band. (Tuner mode only)
Local/Distance Tuning	LOCAL OFF	Activates distance tuning. (Tuner mode only)
	LOCAL ON	Activates local tuning for strong station reception only. (Tuner mode only)
Tuner Frequency Spacing	FREQ USA	Programs the unit to USA tuner spacing. (200kHz for FM and 10kHz for AM). (Tuner mode only)
	FREQ EUR	Programs the unit to European tuner spacing. (50kHz for FM and 9kHz for AM). (Tuner mode only)
Delete Tags	DEL TAGS	Press SELECT to permanently delete all iTunes Tags currently saved in the unit. (HDM90 required for HD Radio™ function - sold separately.)
Tuning Mode	TUNER DIGITAL	Programs the unit to tune to digital and analog radio stations. (HDM90 required for HD Radio function - sold separately.)
	TUNER ANALOG	Programs the unit to tune to analog radio stations only. (HDM90 required for HD Radio function - sold separately.)
Selectable iPod Control	IPOD CNT FULL	Programs the head unit to advanced control of the iPod/iPhone device.
	IPOD CNT MANUAL	Programs the head unit to basic control of the iPod/iPhone device and allows music to be controlled from the iPod/iPhone device.
Loudness Curve	LOUD OFF	Disables the loudness function.
	LOUD ON	Enables the loudness function. Activating this feature will enhance the bass and treble frequencies when listening to music at low volumes.
Clock Display	CLOCK OFF	Programs unit to not display the clock when the power is off.
	CLOCK ON	Programs unit to display the clock when the power is off.
Auxiliary Input	AUX ON	Enables the front panel 3.5mm auxiliary input.
	AUX OFF	Disables the auxiliary input.
Beep Confirmation	BEEP OFF	Disables the confirmation beep.
	BEEP ON	Enables the confirmation beep.
Programmable Turn On Volume	PRO-VOL #	Programs unit to always turn on at a specific volume (default is OFF). Any volume level 1-46 can be selected.
Power on Message	MESSAGE OFF	Disables power on message. (example: GOOD MORNING)
	MESSAGE ON	Enables power on message to be displayed.
Scrolling Option	SCROLL 15 SEC	Programs unit to scroll information once every 15 seconds.
	SCROLL ONCE	Programs unit to scroll once, then show first 10 characters on display.
	SCROLL ON	Programs unit to scroll continuously.
	SCROLL OFF	Programs unit to show the first 10 characters on the display.
Illumination Dimmer	DIMMER HIGH	Programs unit to the brightest illumination level.
	DIMMER MEDIUM	Programs unit to the middle illumination level.
	DIMMER LOW	Programs unit to the dimmest illumination level.
Demonstration Mode	DEMO OFF	Disables the demonstration mode.
	DEMO ON	Enables the demonstration message.



Audio Menu

Press **AUDIO/MENU** momentarily to cycle between Bass, Treble, Balance, Fader, Equalizer, Subwoofer, High Pass Filter and Source Volume Level. Press **ESC** at any time to exit the audio menu.

→ **BASS** → **MIDDLE** → **TREBLE** → **BALANCE** → **FADER** → **EQ** → **SUBWOOFER** → **SOURCE LEVEL** →

Bass	Press AUDIO/MENU until BASS appears, then rotate the volume knob left/right to adjust (-6 minimum / +6 maximum).
Middle	Press AUDIO/MENU until MIDDLE appears, then rotate the volume knob left/right to adjust (-6 minimum / +6 maximum).
Treble	Press AUDIO/MENU until TREBLE appears, then rotate the volume knob left/right to adjust (-6 minimum / +6 maximum). Note: Bass, Middle and Treble settings are retained for each mode individually.
Balance	Press AUDIO/MENU until BALANCE appears, then rotate the volume knob left/right to adjust (BALANCE LEFT 12 to BALANCE RIGHT 12). "BALANCE EVEN" represents equal balance.
Fader	Press AUDIO/MENU until FADER appears, then rotate the volume knob left/right to adjust (FADER FRONT 12 to FADER REAR 12). "FADER EVEN" represents equal fader.
EQ	Press AUDIO/MENU until EQ appears. Rotate the volume knob left/right to select between FLAT (default), POP, JAZZ, CLASSIC, BEAT, ROCK and USER equalization curves. Press SELECT to confirm. Any manual adjustment to the Bass, Middle or Treble settings are automatically saved as USER.
Subwoofer	Press AUDIO/MENU until SUBWFR appears, then press SELECT to confirm. Rotate the volume knob left/right to adjust (0-12). Adjusting the level to 0 turns the subwoofer off.
Source Volume Level	The source volume level control allows a gain adjustment for each audio source. Set the source volume level for each mode, depending on the relative volume of each audio source. To set the source volume level, press AUDIO/MENU until "SOURCE LEVEL" appears. After one second, the current mode will appear on the display. Turn the volume knob to adjust the audio level of the current source (-6 minimum/+6 maximum). Note: Only the current mode will be available for adjustment. Change to another mode to set the source level for that mode.

Audio Menu - Advanced Control

The XML8150 includes advanced audio control to provide superior adjustability in the sound output. These adjustments include:

- **Center Frequency** - focuses bass, mid, and treble adjustments around a specific frequency.
- **Quality ("Q") Factor** - narrows or expands the bass or mid bandwidth around the center frequency.
- **Low Pass Filters** - removes mid and treble frequencies from the subwoofer RCA outputs.

These advanced audio controls are located as sub-menu items in the audio menu as shown below.

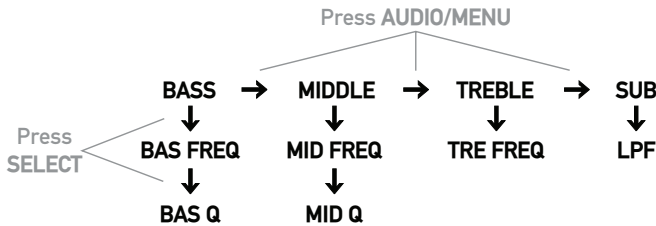

Bass Center Frequency Press **AUDIO/MENU** until **BASS** appears. Then press **SELECT** until **BAS FREQ** appears. Rotate the **volume knob** to adjust (60Hz - 80Hz - 100Hz - 200Hz).

Middle Center Frequency Press **AUDIO/MENU** until **MIDDLE** appears. Then press **SELECT** until **MID FREQ** appears. Rotate the **volume knob** to adjust (500Hz - 1kHz - 1.5kHz - 2.5kHz).

Treble Center Frequency Press **AUDIO/MENU** until **TREBLE** appears. Then press **SELECT** until **TRE FREQ** appears. Rotate the **volume knob** to adjust (10kHz - 12.5kHz - 15kHz - 17.5kHz).

Bass "Q" Factor Press **AUDIO/MENU** until **BASS** appears. Then press **SELECT** twice until **BAS Q** appears. Rotate the **volume knob** to adjust (1.0 - 1.25 - 1.5 - 2.0).

Mid "Q" Factor Press **AUDIO/MENU** until **MIDDLE** appears. Then press **SELECT** twice until **MID Q** appears. Rotate the **volume knob** to adjust (0.5 - 0.75 - 1.0 - 1.25).

Low Pass Filters Press **AUDIO/MENU** until **SUBWFR** appears. Then press **SELECT** until **SUB LPF** appears. Rotate the **volume knob** to adjust (OFF - 80Hz - 120Hz - 160Hz).

Note: When using the LPF feature, set any crossover on the amplifier to full range or off, to avoid filtering of audio frequencies twice.



AM/FM Tuner Operation

Display	<p>When using the XML8150 without the optional HDM90, press DISP to toggle the display between the following options:</p> <p>(LINE 1) FREQUENCY (LINE 2) BAND/PRESET → FREQUENCY CLOCK</p>
Seek Tuning	<p>Press TUNE ◀◀ or TUNE ▶▶ for more than one second to seek the next strong station.</p>
Manual Tuning	<p>Press TUNE ◀◀ or TUNE ▶▶ momentarily to move radio frequency up or down one step at a time. Press and hold to advance quickly.</p>
Scan Tuning	<p>Press SCAN on the remote control momentarily to preview strong stations on the current band, pausing for five seconds at each. Press SCAN on the remote control again to cancel.</p>
Band	<p>Press BAND to select between FM1, FM2, FM3, AM1 and AM2 bands. Up to six presets can be programmed for each band.</p>
Storing and Recalling Station Presets	<p>Up to 18 FM stations and 12 AM stations can be stored in memory. To store a station, select the desired band and station. Press and hold the desired preset button (1-6) for more than two seconds. When stored, the preset number will appear in the display. The station can be recalled by pressing the corresponding preset button.</p>



HD Radio™ AM/FM Tuner Operation

Connecting the HDM90 (sold separately)

HD Radio operation requires connecting the HDM90 HD Radio tuner (sold separately). Refer to the HDM90 instructions for connection details.

Display

When the unit is tuned to an HD Radio station, press DISP to toggle the display between the following options:



HD Radio Tuning

Refer to the instructions for seek, manual and scan tuning on page 10.

When HD Radio station is selected, an HD Radio logo will begin to flash on the display. After about five seconds, HD or HD1 will illuminate after the radio frequency.

- If "HD" appears, the radio station is broadcasting a higher quality sound. No additional stations are available.
- If "HD1" appears, additional multicast channels (HD2 and/or HD3) are available. Press **TUNE** ►► to tune to other available multicast channels.

HD Seek Mode

To activate HD Seek, press **SELECT** from tuner mode to access the HD Seek menu. Turn the **volume knob** to choose the HD ONLY option, then press **SELECT** to confirm. The HD SEEK icon will appear on the display, indicating that the unit will skip over analog stations and tune to HD Radio stations only.

Select **OFF** from the HD Seek menu to cancel.

Auto Station Store

While in HD SEEK mode, the AUTO STORE menu option will automatically store only HD Radio stations, beginning from the lowest frequency.

Note: Multicast channels (HD2 and/or HD3) are not automatically stored with this feature but can be stored by holding the desired preset number (1-6) for 3 seconds.

Setting HD Radio Presets

HD Radio multicast stations (HD2 and HD3) can be stored as presets in the same way as analog radio stations. Press and hold a preset button until it beeps to store the preset.

Recalling an HD Radio Multicast Preset

When selecting a preset multicast station, "LINKING" will appear in the display for approximately 5 seconds while the multicast station information is received.

Note: If the HD Radio signal on the preset is unavailable, the unit reverts to the previous analog or digital station.



iTunes® Tagging Operation (HDM90)

Overview	The iTunes Tagging feature of the XML8150 requires the optional HDM90 module (sold separately). Once connected, the HDM90 allows the user to "Tag" songs that are playing on HD Radio™ stations and enables them to be purchased later through iTunes. With the touch of a button the unit will remember the title and artist song information, and then transfer that information to your iPod device the next time you connect it to the XML8150. A new list called "Tagged" will appear in iTunes, giving you the option to purchase each song.
Tagging Music	
Step 1	Tune to an HD Radio station. The HD logo in the display must remain solid - indicating that a digital station is tuned. If the song has valid artist and song title information, the MODE/TAG button will turn red.
Step 2	Press and hold the MODE/TAG button. TAGGING SONG will appear, followed by TAG STORED, confirming the song information has been saved to internal memory. The song information will be saved in memory until an iPod device is plugged in. Up to 64 Tags can be saved before they must be transferred or deleted.
Step 3	Plug in an iPod device. All the Tags currently in memory will be automatically transferred, deleting the Tags from the head unit's memory. See page 16 for connection details. Note: The XML8150 must remain in operation of iPod mode until the Tags are successfully transferred. If an iPod device is plugged in when a song is tagged, press MODE until the XML8150 is in operation of iPod mode. Tags will transfer automatically. (see page 13 for compatibility with iPod devices).
Step 4	After the Tag transfer to the iPod device is complete, the XML8150 will display the number of tags that were successfully transferred. Sync with iTunes. A list named "Tagged" will appear on the left in the iTunes software. Click on the "Tagged" list to view all the songs that have been tagged and click the "view" button for purchase information. Note: Some iPod devices may require you to select 'transfer purchases' in the context menu from the name of your iPod device to transfer Tags to iTunes.
Deleting All Tags	To delete all the saved tags without transferring them to an iPod device, change to tuner mode, then press AUDIO/MENU for 3 seconds to enter the setup menu. Press AUDIO/MENU once more until DEL TAGS appears along with the number of tags saved in memory. then press SELECT . A confirmation message will appear. Note: Once transferred, Tags are managed from the iTunes software.

iTunes® Tagging Operation (HDM90)

Troubleshooting

Displayed Message	Description
CHECK iPod VER	There is a compatibility issue with the iPod device that is connected. Check the list of compatible iPod devices below.
	If the attached iPod device is compatible, update the firmware to the latest version using iTunes.
SENDING TAGS	Tags are being sent to the iPod device. This process can take several minutes depending on the number of Tags being sent.
iPod FULL	There is not enough space on the connected iPod device to transfer the iTunes Tags. Free up space using iTunes.
TRANSFER FAILED	Connection error. Ensure the iPod device is powered on and reconnect the iPod device until a TAGS SENT confirmation is displayed.
ALREADY TAGGED	The same song has already been tagged from the same radio station, and is currently saved in memory. The same song cannot be tagged twice - unless the song is tagged on a different radio station, the Tags are sent to an iPod device or the tags are erased.
MEMORY FULL CONNECT iPod	The internal memory of the HDM90 will hold 64 Tags. An iPod device must be connected to transfer the Tags, or the Tags must be deleted before more songs can be tagged.
NO TAG INFO	There is not sufficient information (artist or title) to tag the song. Some HD Radio™ stations or certain songs may not fully support iTunes Tagging.
TAGGING FAILED	There was an error saving the Tag information to the internal memory. Press and hold the MODE/TAG button again.
NO TAGS STORED	There are no tags saved in the internal memory. The DELETE TAGS function can only delete Tags that are saved in the internal memory.

Device Compatibility with iTunes Tagging

Compatible with

- *iPhone 4
- *iPhone 3GS
- *iPhone 3G
- *iPhone
- iPod nano (5th generation)
- *iPod touch (2nd generation)
- iPod nano (4th generation)
- iPod classic
- *iPod touch (1st generation)
- iPod nano (3rd generation)

*Some iPod devices may require you to select 'transfer purchases' in the context menu from the name of your iPod device to transfer Tags to iTunes.

Go to www.apple.com/itunes for the latest version of the iTunes software.



Dock for iPod - Removing the Dock

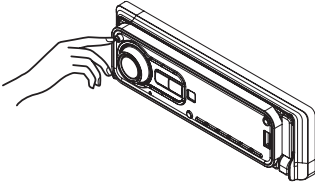

Press the **RELEASE** button on the top left corner of the front panel.

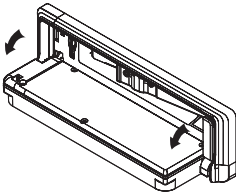

Fold down front panel. The dock is located behind the panel.

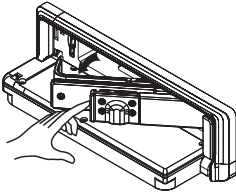

Using handle on the dock, pull dock out and towards the right side of the unit.

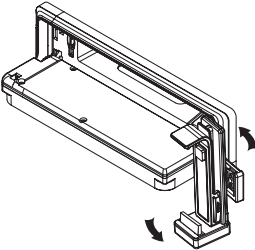

Rotate dock 90 degrees counterclockwise to the vertical position.

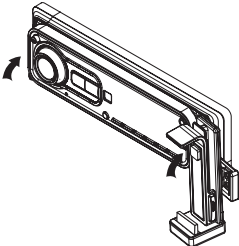

Fold up and close the front panel of the unit.

Dock for iPod - Docking a Device

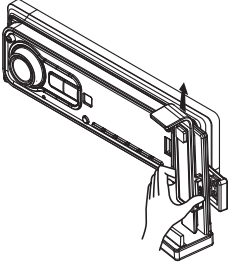

To dock an iPod/iPhone device, squeeze the side **PUSH** buttons and raise the top support of the dock to provide clearance for the device.

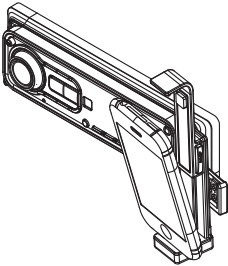

Line up the dock connector on the iPod/iPhone device with the connector located on the bottom of the dock.

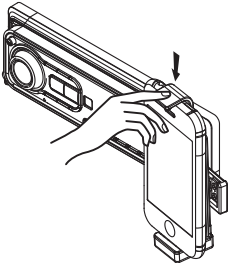

Lower the top support of the dock until the iPod/iPhone device is properly secured.

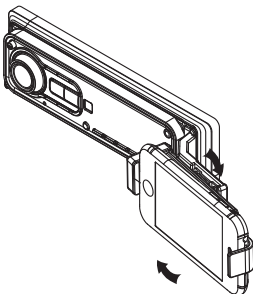

The dock may be rotated to the landscape position if desired.



Connecting an iPod/iPhone Device

The XML8150 features two different methods of connecting iPod or iPhone devices:

Fold-out Docking Station

Remove the dock from the XML8150 and dock an iPod or iPhone device as shown on pages 14-15. When a device is docked, playback will begin automatically.

Direct USB Connection



To play music from an iPod/iPhone device using the direct USB interface, connect the USB cable (included with your iPod/iPhone device) to the XML8150's USB port. Once connected, playback will begin automatically.

Note: If a song is playing on the iPod or iPhone device before it is connected, it will continue to play after being connected.

Operation of iPod/iPhone - Full Control

When the control of iPod/iPhone feature is set to "FULL" in the setup menu, use the following functions to control the device:

Song Select

Press **▶▶** to skip to the beginning of the next song.
Press **◀◀** to return to the beginning of the current song.
Pressing **◀◀** again skips to the beginning of the previous song.

Fast Forward and Reverse

Press and hold **▶▶** or **◀◀** to fast forward or reverse a song.

Pause

Press **▶/||** to temporarily stop playback.
Press **▶/||** again to resume playback.

Repeat

Press **RPT** to enter the Repeat menu, then turn the **volume knob** to select one of the following options:

- OFF - Repeats all tracks.
- SONG - Repeats selected track.

Random

Press **RDM** to enter the Random menu, then turn the **volume knob** to select one of the following options:

- OFF - Cancels the **RDM** function.
- ALL - Plays all tracks in random order.
- ALBUM - Plays all tracks in the selected album in random order.

Intro

Press **INT** to enter the Intro menu, then turn the **volume knob** to select one of the following options:

- OFF - Cancels the **INT** function.
- ON - Plays first 10 seconds of each track.

Operation of iPod/iPhone - Full Control

Displaying Information

Press **DISP** to select the display options as follows:

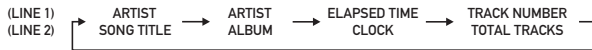

Character Support

Only alphanumeric characters can be displayed (ASCII type). "NO SUPPORT" will be displayed if the file contains characters that can not be displayed. "NO FILE" will be displayed if there are no songs in the selected playlist.

Maximum character display information

- *Song title – 32 character maximum
- *Artist name – 32 character maximum
- *Album name – 32 character maximum

*Song Title, Artist Name and Album name will only be displayed if included with the file.

Music Search Menu

The XML8150 features a powerful music search that simplifies the searching process. Follow the steps below to find the desired song:

- Step 1** While in operation of iPod mode, press **SELECT** once to enter the search menu.
- Step 2** Turn the **volume knob** to select between **playlist, artist, album, song, audiobook, podcast and genre**. Press **SELECT** to select the desired search category. Some categories have subcategories to navigate through.
- Step 3** Navigate to the desired song and press **SELECT** to begin playback. Use the table below for reference when navigating through the menu options.

Note: Press **ESC** to access the previous level (up one level). Pressing **ESC** from the search main menu will exit the search.

Note: If a specific category is selected, the iPod/iPhone device playback will be limited to that category until another category is selected in the search menu.

See the below table for a list of the search menu navigation options.

Search Category	Menu Navigation
Playlist	Menu → Playlists → Songs
Artist	Menu → Artists → Albums → Songs
Album	Menu → Albums → Songs
Song	Menu → Songs
Audiobook	Menu → Audiobooks
Podcast	Menu → Podcasts
Genre	Menu → Genre → Genres List → Artists → Albums → Songs



Operation of iPod/iPhone - Manual Control

When the control of iPod/iPhone feature is set to "MANUAL" in the setup menu, use the following functions to control the device:

Manual Control for iPod	When "MANUAL" control is selected from the setup menu, the iPod or iPhone device can be controlled directly from the device's interface. All functions except for volume can be used from the iPod or iPhone device.
Basic Head Unit Control	In addition to manual control of the iPod/iPhone device, the following basic functions are still active:
Song Select	Press ►► to skip to the beginning of the next song. Press ◄◄ to return to the beginning of the current song. Pressing ◄◄ again skips to the beginning of the previous song.
Pause	Press ►/ to temporarily stop playback. Press ►/ again to resume playback.
Volume	When playing an iPod device, the volume is adjustable using the volume controls on inside panel.

Device Compatibility

- Made for**
- iPod nano (5th generation)
 - iPod touch (2nd generation)
 - iPod nano (4th generation)
 - iPod classic
 - iPod touch (1st generation)
 - iPod nano (3rd generation)
 - iPod nano (2nd generation)
 - iPod with video
 - iPhone 4
 - iPhone 3GS
 - iPhone 3G
 - iPhone

Note: See page 13 for iPod and iPhone device compatibility with iTunes Tagging.

USB/SD Card Operation

Connecting a USB Device (sold separately)	To play MP3/WMA/AAC files from most mass storage devices, connect a device to the XML8150's USB port.
Connecting a SD Card (sold separately)	To play MP3/WMA/AAC files from an SD Card, insert an SD card into the XML8150's SD card slot, located behind the front panel. Insert the SD card with the label facing to the left, and press the card until it clicks into place. Remove the SD card by pressing in until it clicks, then pull to remove.
Playing Music	When a USB or SD card device is first connected, playback will begin momentarily. Depending on the number of files and folders, it may take several seconds for the device to begin playing. If no valid MP3/WMA files are detected, "NO FILE" will be displayed and the last mode will be resumed.
Track Select	Press TRACK ►► to skip to the beginning of the next track. Press TRACK ◄◄ to return to the beginning of the current track. Pressing TRACK ◄◄ again skips to the beginning of the previous track.
Fast Forward and Reverse	Press and hold TRACK ►► or TRACK ◄◄ to fast forward or reverse a track.
Pause	Press ►/ to temporarily stop USB playback. Press ►/ again to resume playback.

File and Folder Search

Begin Searching	Press SELECT to enter the USB file/folder search mode. An alphabetical list of files and folders in the current folder from the USB/SD card device will be displayed.
Search menu controls	<ul style="list-style-type: none"> • Turn the volume knob to cycle through the list of files and folders. • Press SELECT to change to the selected folder or play the selected file. • Press ESC to change to the previous folder or to exit the search menu (from the "ROOT" folder).
File and Folder names	<p>The FOLDER icon will illuminate when a folder name is currently being displayed.</p> <p>The FILE icon will illuminate when a file name is currently being displayed.</p> <p>Note: Files not located in a folder will appear in the "ROOT" folder.</p>

USB / SD Card Operation

Displaying Information

When a file is accessed, the clock and elapsed time will be displayed. Press **DISP** momentarily to select file name (default), song title, artist, track number or clock & elapsed time.

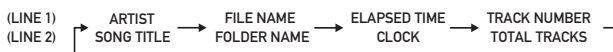

- "NO TITLE" will be displayed if no song title information is available.
- "NO ARTIST" will be displayed if no artist information is available.

Song Title Icon **[TITLE]**

This icon will illuminate when the song title is displayed.

Artist Icon **[ARTIST]**

This icon will illuminate when the artist name is displayed.

Folder Icon **[FOLDER]**

This icon will illuminate when the folder name is displayed.

File Icon **[FILE]**

This icon will illuminate when the file name is displayed.

Folder Access

Press **[Left Arrow]** to select the previous folder.

Press **[Right Arrow]** to select the next folder.

Note: Folder access is only available on USB/SD Card devices with more than one folder.

Repeat

Press **RPT** to enter the Repeat menu, then turn the **volume knob** to select one of the following options:

- OFF- Plays all tracks on the USB/SD Card device.
- TRACK - Continuously repeats selected track.
- FOLDER - Continuously repeats all files in selected folder.

Random

Press **RDM** to enter the Random menu, then turn the **volume knob** to select one of the following options:

- OFF - Cancels the **RDM** function.
- ALL- Plays all tracks in random order.
- FOLDER - Plays all tracks in folder in random order.

Note: Random mode is retained in memory when selecting between other modes and when the unit is turned on/off.

Intro

Press **INT** to enter the Intro menu, then turn the **volume knob** to select one of the following options:

- OFF - Cancels the **INT** function.
- ALL - Plays first 10 seconds of each track.
- FOLDER - Plays first 10 seconds of each track in folder.

USB / SD Card Operation

Character Support

- Maximum character display information
- Track name – 32 character maximum
 - Directory name – 32 character maximum
 - *Song title – 30 character maximum
 - *Artist name – 30 character maximum

*Song title and artist name will only be displayed if included with the MP3/WMA file.

Media Compatibility

The following types of files are compatible:

- MP3 data (.mp3 file extension)
- WMA data (.wma file extension)
- AAC data (.m4a file extension)

The following types of files are not compatible:

- WMA files that are protected by DRM (Digital Rights Management).
- AAC files that are protected by DRM (Digital Rights Management).
- MP3 PRO format
- MP3 playlists

Playback Order

MP3/WMA/AAC playback sequence is based on order the files are copied to the USB/SD Card device and begins in the root folder. Any empty folders or folders that do not include MP3/WMA/AAC files are skipped. Depending on your software, the playback order may vary.

Playback Capacity

- Maximum number of files: 65535
- Maximum number of folders: 2000
- Maximum number of files in each folder and root: 65535
- Maximum number of folder levels (sub folders): 65535

Note: If the number of files/folders exceeds the maximum outlined above, the additional files/folders will be ignored.

Note: Some devices that exceed the maximum number of files or folders may not function properly.

Device Compatibility

Due to the differences of USB and SD card devices, some devices may not be compatible. Devices must be 'mass storage class' and formatted to the FAT or FAT32 file system in order to ensure compatibility.

SD Cards must have a capacity of 32GB or smaller to be compatible.



USB / SD Card Operation

Sampling Frequency Rates

MP3 8kHz ~ 48kHz

WMA 32kHz ~ 48kHz

AAC 8kHz - 48kHz

Transfer Bit rates

MP3 32kbps ~ 320kbps constant
Variable bit rates

WMA 32kbps ~ 192kbps constant
Variable bit rates

AAC 48kbps - 288kbps constant
Variable bit rates

Note: Some files may not play or be displayed correctly, depending on sampling rates and bit rates.

MP3 Tag Display

ID3 tags Version 1.0 to 2.0

Note: If an invalid ID3 tag version is detected, "NO SUPPORT" will scroll on the display.





Bluetooth® Operation

Pairing a Device

Preparation	Before you can use a Bluetooth device, it must be paired and connected. Make sure that Bluetooth is activated on your device before you begin the pairing process.
Pairing a New Device	<p>The XML8150 broadcasts the pairing signal constantly when no devices are currently connected. Complete the pairing sequence from your Bluetooth device. Refer to the owner's manual for your device for more details.</p> <p>The device name is "XML8150" The Bluetooth passcode "1234"</p> <p>Note: The XML8150 can be in any mode of operation when pairing is performed.</p>
Pairing Additional Devices	If a device is currently connected, press and hold  to disconnect the current device before a new device can be paired. Then begin the pairing sequence from the new Bluetooth device.

Connecting a Paired Device

Most Bluetooth devices support the auto-connect feature, and will connect automatically if the device is in range when the XML8150 is powered-on. If your device was previously paired but does not connect, use these instructions below.

- If your most recently connected Bluetooth device becomes disconnected or does not reconnect, press  from Bluetooth mode to reconnect your mobile device.
- To connect a previously paired device that was not recently connected:
 - 1) If applicable, press and hold  to disconnect any connected mobile devices.
 - 2) From Bluetooth mode, press **SELECT**. "PAIRED DEVICES" will appear on the LCD.
 - 3) Turn the volume knob to cycle through the list of devices 1 through 10.
 - 4) Press **SELECT** or  to connect to the desired device. It must be in range to connect.

Note: If the **AUTO-CON** setup menu setting is set to **OFF**, you must press  to connect you device after pairing, and each time the XML8150 is powered-on.

Disconnecting a Device



Press and hold  for 3 seconds to disconnect a connected device. The device will remain paired and appear in the PAIRED DEVICES menu, but not be connected.



Bluetooth® Operation



Making a Phone Call

Manual Dialing

- Press  once. "ENTER NUM" will be shown, then an "_" will appear on the display.
- Using the remote control, enter the phone number using the 0-9 buttons. Press  on the remote control or XML8150 front panel to begin dialing.

Note: Placing a phone call from your cell phone will also use the Bluetooth function of the XML8150.

Recent Calls List

- Press  twice from Bluetooth mode to view the 10 most recent phone calls that were dialed, received or missed while connected to the XML8150.
- Turn the volume knob to cycle through the recent phone numbers. Press SELECT or  to dial the phone number.

Redialing the last number



To redial the last phone number, press  three times from Bluetooth mode. Dialing will begin automatically.

Receiving and Ending Phone Calls

Receiving a Phone Call

Incoming phone calls will automatically appear on the display and a ring tone will be heard.

Note: The volume of the ring tone depends on the volume level of the XML8150. The incoming ring tone may not be heard if the volume is set to a low level or mute is activated.

- Press  to receive the incoming phone call.
- Press  to refuse the incoming phone call.





Note: If AUTO ANS is set to ON in the setup menu, all phone calls will be received automatically.

Ending a Phone Call

During an active phone call, press  to end a phone call. If the phone call was received when listening to music in another mode, the XML8150 will resume the previous mode.

Bluetooth[®] Operation

During a Phone Call

Volume	Turn the volume knob to adjust the volume level during a phone call. Bluetooth mode has a separate volume level from the main volume of other modes. The XML8150 will remember the volume level in Bluetooth mode and always return to the last volume level for each phone call.
Microphone Mute	Press MUTE during a phone call to turn the XML8150's external microphone off. Press MUTE again to resume microphone operation.
Audio Transfer	Press DISP during a phone call to transfer the call from the XML8150 to the cell phone. Press DISP again to toggle the audio back to the XML8150.
Call Waiting	During a phone call, if there is a second incoming call, press  to place the first call on hold and switch to the second phone call. Press  again to switch back to the first call.
Call Hold	During a phone call, when there are no additional incoming calls, press  to place the call on hold. Press  again to resume the phone call.

Note: Audio transfer, call waiting and call hold must be supported by the mobile phone and service provider to function properly.



Bluetooth® Operation

Streaming Audio Operation

The XML8150 supports A2DP (advanced audio distribution profile) wireless streaming audio from your Bluetooth mobile device directly to your head unit. You can also control your music from the front panel of the head unit using AVRCP (audio video remote control profile).

Notes:

- To stream music to your head unit, your mobile device must support the A2DP and AVRCP Bluetooth profiles. Check the owner's manual of your mobile device for details.
- Streaming audio must be enabled from your mobile device. This option will vary depending on the device. Some devices allow streaming audio to be disabled.

After pairing, connecting and enabling streaming audio from a compatible mobile device, begin playing music using the music player on your mobile device. Once the music is playing, the following functions can be used to control the music:

- The ►► button will skip to the next available audio track.
- The ◀◀ button will skip to the previous audio track.
- The ►/|| button will toggle between play and pause during playback.
- The ⏻ button will stop the audio playback.

Note: Some Bluetooth devices may not fully support these commands.

Bluetooth Reset

Resetting the Bluetooth module will remove the list of paired phones and delete the list of recent calls from memory.

To reset Bluetooth, perform the following steps:

- 1) Press **MODE** until the head unit is in Bluetooth mode.
- 2) Press and hold **MODE** for 3 seconds to reset the Bluetooth settings back to the factory default.

Compatibility Note:

Due to the differences in Bluetooth technology, some mobile devices may be incompatible, function improperly or may not support all features when used with the XML8150.

Bluetooth® Operation

Bluetooth Setup Menu

To enter the setup menu, press and hold **AUDIO/MENU** for more than 3 seconds. Press **AUDIO/MENU** to cycle through menu options. When desired option appears in the display, rotate the **volume knob** left/right to adjust or activate the desired function. Press **ESC** to exit the menu at any time.

Menu Function	Options	Action
Bluetooth Mode	BL'TOOTH ON	Enables the Bluetooth feature. The Bluetooth icon will flash occasionally when not paired and connected to a mobile device.
	BL'TOOTH OFF	Disables the Bluetooth feature.
Auto Connect	AUTO CON ON	Allows the XML8150 to automatically (re)connect to the most recently connected mobile device. Note: Some mobile devices do not support this feature.
	AUTO CON OFF	Disables the auto connect feature. To connect a Bluetooth device, you must use the "PAIRED DEVICES" menu each time.
Auto Answer	AUTO ANS OFF	Disables the auto answer feature. Press  to receive an incoming call.
	AUTO ANS ON	All incoming calls will be answered automatically after 2-3 rings without notification.
Bluetooth Audio	BT SPKRS FRONT	Directs the Bluetooth audio to only the front speakers. This setting affects the speaker and RCA outputs.
	BT SPKRS ALL	Directs the Bluetooth audio to all 4 speakers.



Limited One Year Warranty

This warranty gives you specific legal rights. You may also have other rights which vary from state to state.

Dual Electronics Corp. warrants this product to the original purchaser to be free from defects in material and workmanship for a period of one year from the date of the original purchase.

Dual Electronics Corp. agrees, at our option, during the warranty period, to repair any defect in material or workmanship or to furnish an equal new, renewed or comparable product (whichever is deemed necessary) in exchange without charges, subject to verification of the defect or malfunction and proof of the date of purchase. Subsequent replacement products are warranted for the balance of the original warranty period.

Who is covered? This warranty is extended to the original retail purchaser for products purchased and used in the U.S.A.

What is covered? This warranty covers all defects in material and workmanship in this product. The following are not covered: installation/removal costs, damage resulting from accident, misuse, abuse, neglect, product modification, improper installation, incorrect line voltage, unauthorized repair or failure to follow instructions supplied with the product, or damage occurring during return shipment of the product.

What to do?

1. Before you call for service, check the troubleshooting guide in your owner's manual. A slight adjustment of any custom controls may save you a service call.
2. If you require service during the warranty period, you must carefully pack the product (preferably in the original package) and ship it by prepaid transportation with a copy of the original receipt from the retailer to an authorized service center.
3. Please describe your problem in writing and include your name, a return UPS shipping address (P.O. Box not acceptable), and a daytime phone number with your shipment.
4. For more information and for the location of the nearest authorized service center please contact us by one of the following methods:

- Call us toll-free at 1-866-382-5476
- E-mail us at cs@dualav.com

Exclusion of Certain Damages: This warranty is exclusive and in lieu of any and all other warranties, expressed or implied, including without limitation the implied warranties of merchantability and fitness for a particular purpose and any obligation, liability, right, claim or remedy in contract or tort, whether or not arising from the company's negligence, actual or imputed. No person or representative is authorized to assume for the company any other liability in connection with the sale of this product. In no event shall the company be liable for indirect, incidental or consequential damages.

Troubleshooting - General

Problem	Cause	Action
Unit will not turn on (no power)	Yellow wire not connected or incorrect voltage Red wire not connected or incorrect voltage	Check connections for proper voltage (11~16VDC)
	Black wire not connected	Check connection to ground
	Fuse blown	Replace fuse
Unit has power (but no sound)	Speaker wires not connected	Check connections at speakers
	One or more speaker wires touching each other or touching chassis ground	Insulate all bare speaker wires from each other and chassis ground
Unit blows fuses	Yellow or red wire touching chassis ground	Check for pinched wire
	Speaker wires touching chassis ground	Check for pinched wire
	Incorrect fuse rating	Use fuse with correct rating
PROTECT appears on display	The WMA file is copy-protected by DRM (Digital Rights Management)	Write disc using WMA files that are not copy-protected
NO FILE appears on display	Selected file is not available in direct or alphanumeric search modes	Repeat search using valid parameters
INVALID appears on display	The file format is incompatible	Write disc using valid audio files with .mp3, .wma or .m4a file extensions
NO SUPPORT appears on display	An invalid ID3 tag version is present	Version 1.0 to 2.0 ID3 tags are supported.



Specifications

FM Tuner	Tuning range: 87.5MHz-107.9MHz Usable sensitivity: 8.5dBf 50dB quieting sensitivity: 10dBf Stereo separation @ 1kHz: 40dB Frequency response: 30Hz-13kHz
AM Tuner	Tuning range: 530kHz-1710kHz Usable sensitivity: 22uV Frequency response: 30Hz-2.2kHz
General	Speaker output impedance: 4~8 ohms Line output voltage: 2 Volts RMS Dimensions: 7" x 7" x 2" (178 x 178 x 51 mm)
USB/SD Card	File system: FAT, FAT32 File extensions support: .mp3, .wma, .m4a SD Card maximum device capacity: 16GB
Bluetooth® Profiles	HFP (hands-free profile) A2DP (advanced audio distribution profile) AVRCP (audio video remote control profile) PBAP (phone book access profile)

Design and specifications subject to change without notice.



CEA-2006 Power Standard Specifications (reference: 14.4VDC +/- 0.2V, 20Hz~20kHz)

Power Output: 18 Watts RMS x 4 channels at 4 ohms and $\leq 1\%$ THD+N
Signal to Noise Ratio: 80dBA (reference: 1 watt into 4 ohms)



FCC Compliance

This device complies with Part 15 of the FCC Rules. Operation is subject to the following two conditions:

- (1) this device may not cause harmful interference, and
- (2) this device must accept any interference received, including interference that may cause undesired operation.

Warning: Changes or modifications to this unit not expressly approved by the party responsible for compliance could void the user's authority to operate the equipment.

Note: This equipment has been tested and found to comply with the limits for a Class B digital device, pursuant to Part 15 of the FCC Rules. These limits are designed to provide reasonable protection against harmful interference in a residential installation. This equipment generates, uses and can radiate radio frequency energy and, if not installed and used in accordance with the instructions, may cause harmful interference to radio communications. However, there is no guarantee that interference will not occur in a particular installation. If this equipment does cause harmful interference to radio or television reception, which can be determined by turning the equipment off and on, the user is encouraged to try to correct the interference by one or more of the following measures:

- Reorient or relocate the receiving antenna.
- Increase the separation between the equipment and receiver.
- Connect the equipment into an outlet on a circuit different from that to which the receiver is connected.
- Consult the dealer or an experienced radio/TV technician for help.



Dual Electronics Corp.
Toll Free: 1-866-382-5476

www.dualav.com
©2010 Dual Electronics Corp. All rights reserved.

iPhone, iPod, iPod classic, iPod nano, and iPod touch are trademarks of Apple Inc., registered in the U.S. and other countries.

"Made for iPod" and "Made for iPhone" mean that an electronic accessory has been designed to connect specifically to iPod or iPhone, respectively, and has been certified by the developer to meet Apple performance standards. Apple is not responsible for the operation of this device or its compliance with safety and regulatory standards.

The Bluetooth® word mark and logos are owned by the Bluetooth SIG, Inc. and any use of such marks by Namsung is under license.

HD Radio™ and the HD Radio Ready logo are proprietary trademarks of iBiquity Digital Corporation.

The SD logo is a trademark of the SD Card Association.

Other trademarks and trade names are those of their respective owners.

NSA1010-V01